

# PRODUCT INFO

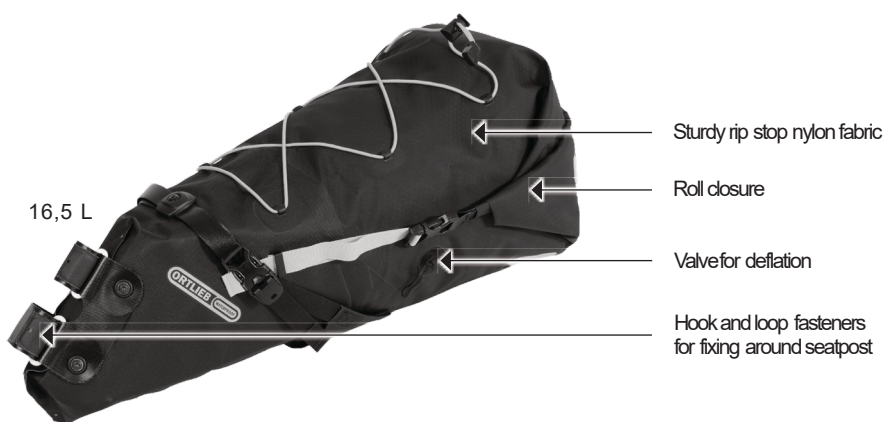

## SEAT-PACK

Waterproof saddlebag



size	height cm/in	width cm/in.	depth cm/in.	vol. L/cu.in.	weight g/oz.	max. capacity kg/lbs.
11 L	26/10.2	40/15.7	15/5.9	4,5 - 11/ 275-671	345/12.2	3/6.6
16,5 L	30/11.8	64/25	22/8.7	8 - 16.5/ 488-1007	430/15.2	5/11.0

### SPECIFICATIONS:

#### 11 L / 16,5 L

- + Waterproof saddlebag with roll closure
- + Ideal for bikepacking, alpcrossing, touring
- + Light weight sturdy PU laminated rip stop nylon
- + Air release valve to easily purge the bag of trapped air, allowing for tighter compression
- + Heavyduty fabric used at the saddle rail mounting location
- + Sturdy PE inner stiffener
- + Saddlebag acts as mudguard
- + Can be mounted to carbon seat posts
- + Daisy chain runs along the underside of the bag, allowing a rear light to be fixed
- + Elastic cord fixations on the upper outer side for quick storage of additional equipment
- + 3M Scotchlite reflectors
- + Suitable for round seatposts with a diameter of max. 34.9 mm

#### 11 L

- + Variable volume between 4.5 and 11.0 litres with adjustable straps and roll closure
- + Heavyduty hook and loop fastener with a soft grippy surface ensure slip-free seat post fixation
- + Maximum capacity 3 kg / 6.6 lbs.

#### 16,5 L

- + Variable volume between 8 and 16.5 litres with adjustable straps and roll closure
- + Heavyduty hook and loop fasteners with a soft grippy surface ensure slip-free seat post fixation
- + Maximum capacity 5 kg / 11 lbs.



# PRODUCT INFO



## SEAT-PACK

Waterproof saddlebag

11 L:



Space required for mounting Seat-Pack 11 L to the seat post

16,5 L:

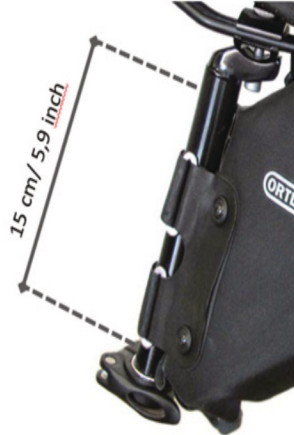

Space required for mounting Seat-Pack 16,5 L to the seat post

Application Example:



Seat-Pack with Seat-Pack Support Strap (optionally available)

**Contents:** Saddlebag with hook and loop fastener, valve, adjustable straps, inner stiffener

**Optional accessory:** Seat-Pack Support-Strap (E216)

**Note:** In order to meet standard IP64 (6=dustproof, 4=protected against splash water coming from all directions) the closure must be rolled 3-4 times.



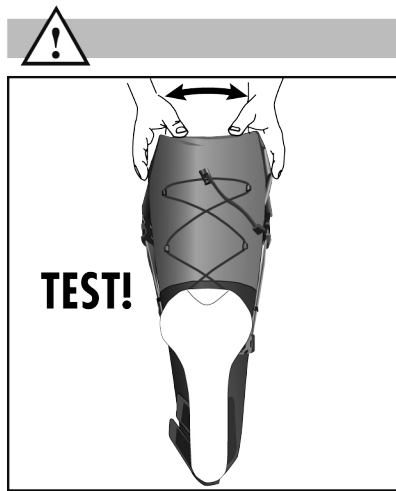
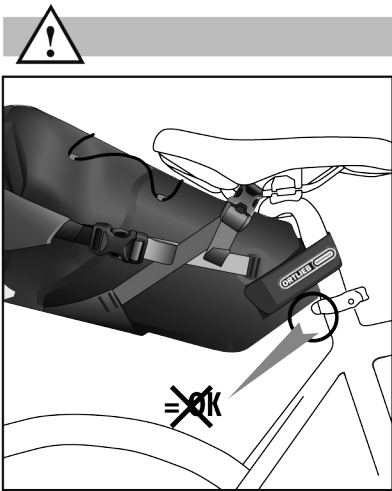

## ACCESSORIES

Support Strap for Seat-Pack = + Art. # E216

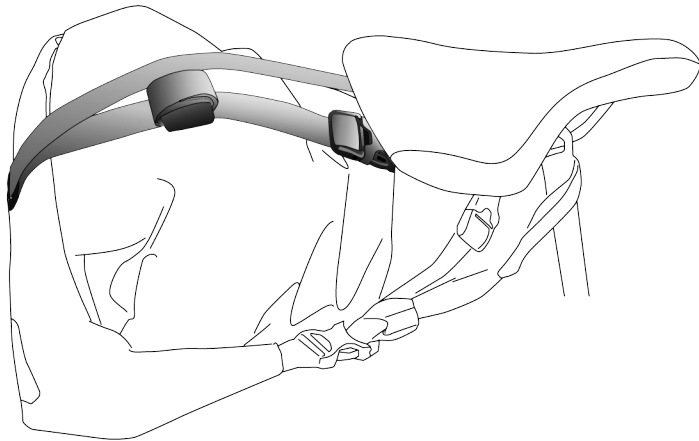
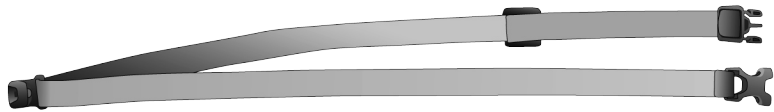

## SEAT-PACK 11 L



- |    |                         |    |                          |
|----|-------------------------|----|--------------------------|
| DE | MONTAGEANLEITUNG        | ES | INSTRUCCIONES DE MONTAJE |
| GB | ASSEMBLY INSTRUCTIONS   | SE | MONTERINGSANVISNING      |
| FR | INSTRUCTIONS DE MONTAGE | NO | MONTERINGSANVISNING      |
| IT | ISTRUZIONI DI MONTAGGIO | FI | ASENNUSOHJEET            |
| NL | MONTAGE HANDLEIDING     | PL | INSTRUKCJA MONTAZU       |
| DK | MONTERINGSVEJLEDNING    | JP | 装着方法                     |

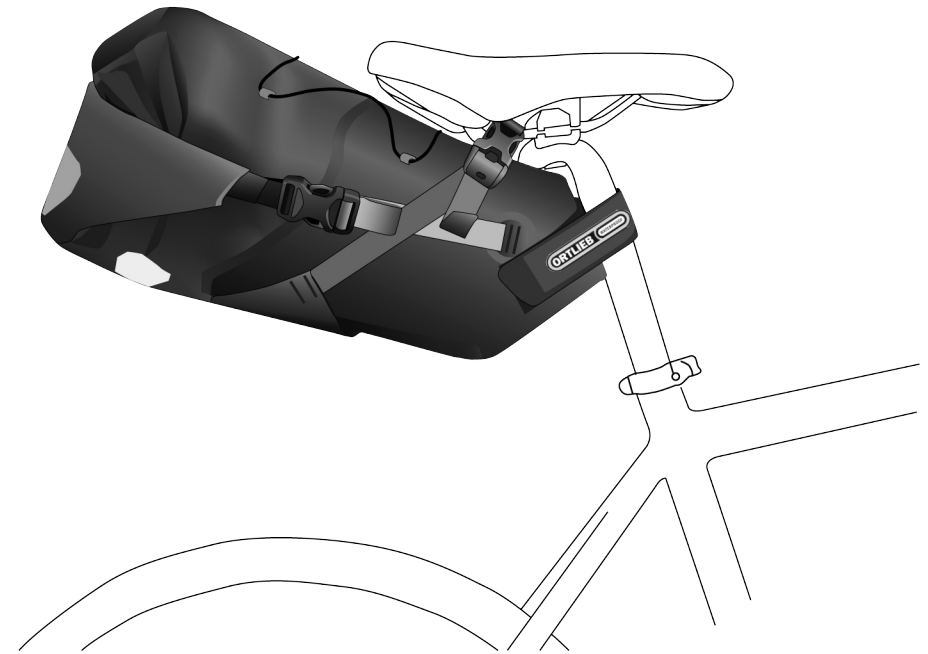

WEITERE INFORMATIONEN:

MORE INFORMATION:

<https://www.youtube.com/watch?v=CuMWYUYhSoM>

[www.ortlieb.com](http://www.ortlieb.com)



WA134 0820

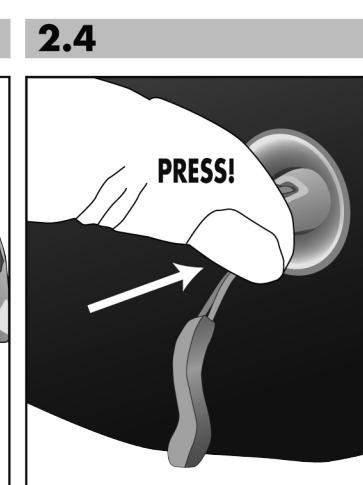
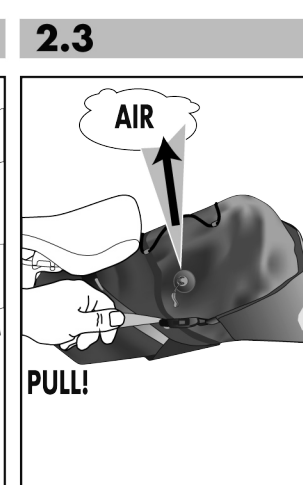
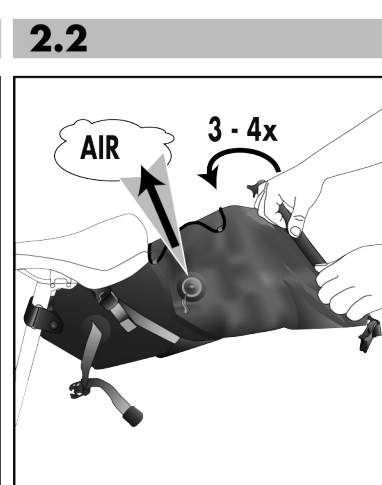
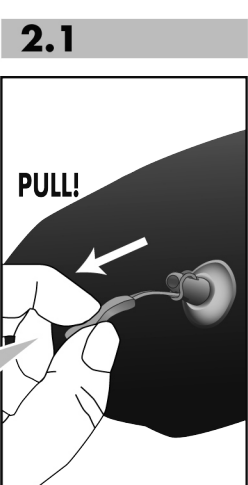
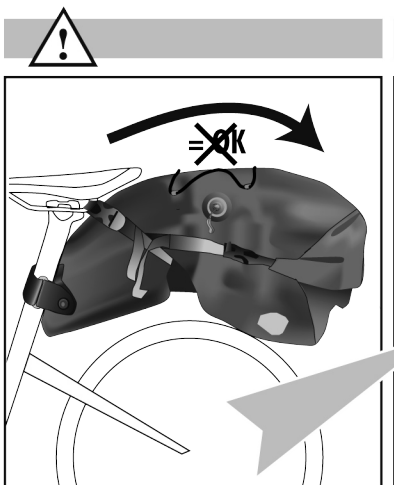
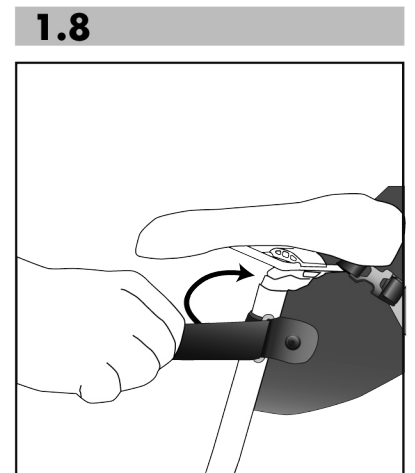
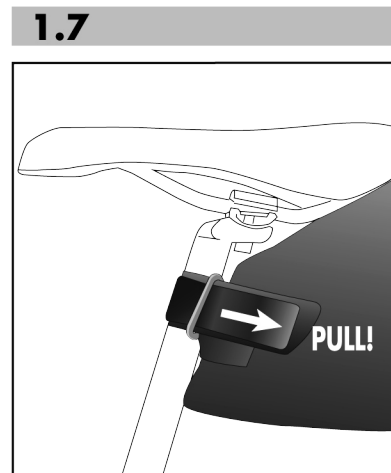
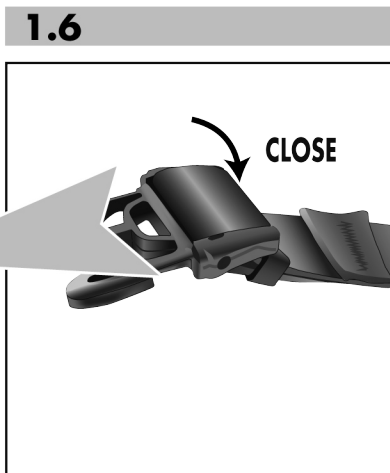
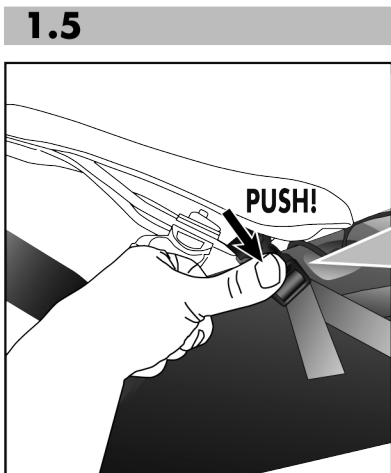
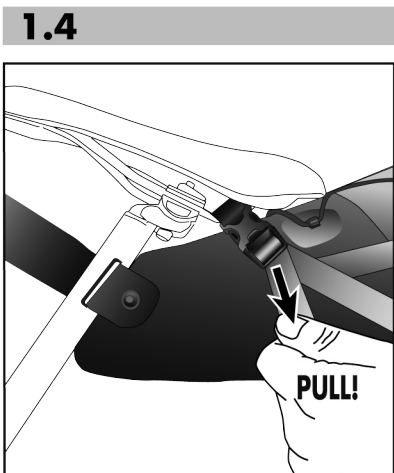
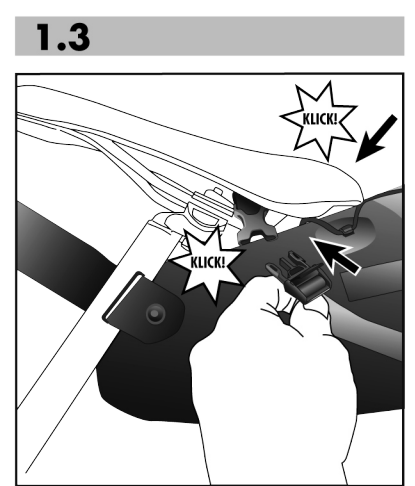
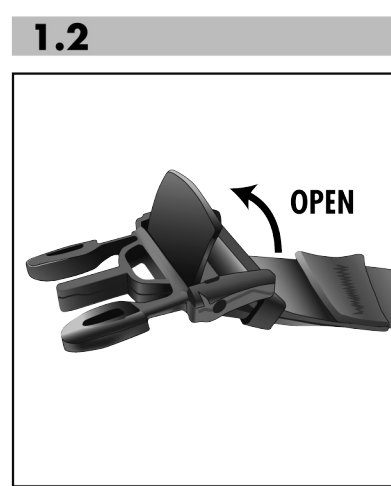
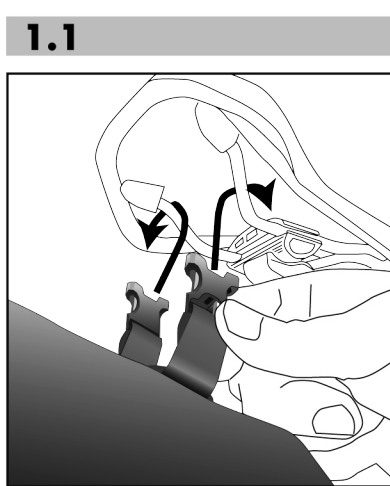
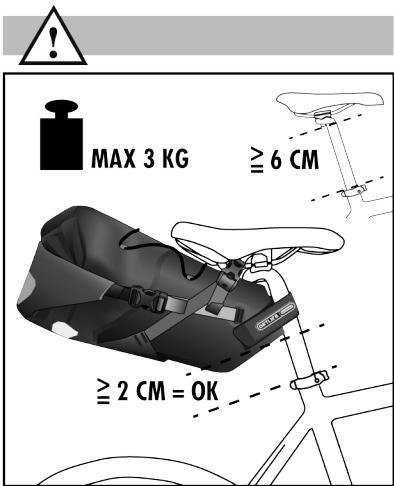

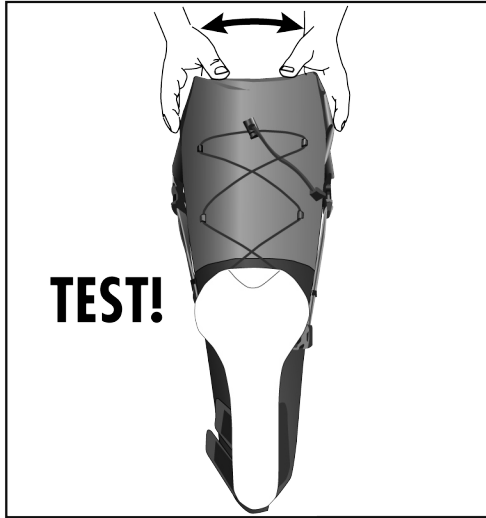
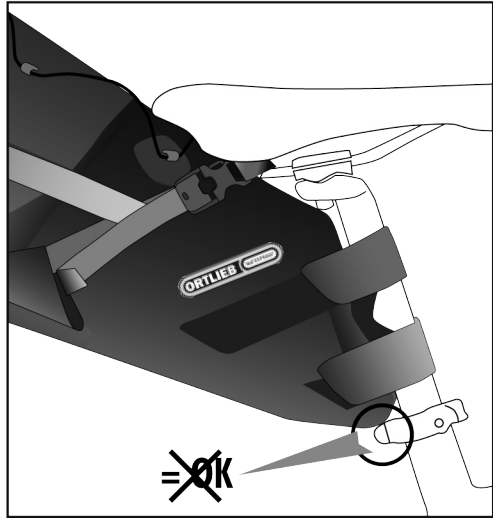

# SEAT-PACK 16,5 L



- DE MONTAGEANLEITUNG
- GB ASSEMBLY INSTRUCTIONS
- FR INSTRUCTIONS DE MONTAGE
- IT ISTRUZIONI DI MONTAGGIO
- NL MONTAGE HANDLEIDING
- DK MONTERINGSVEJLEDNING

- ES INSTRUCCIONES DE MONTAJE
- SE MONTERINGSANVISNING
- NO MONTERINGSANVISNING
- FI ASENNUSOHJEET
- PL INSTRUKCJA MONTAZU
- JP 装着方法

## ACCESSORIES

Support Strap for Seat-Pack = + Art. # E216

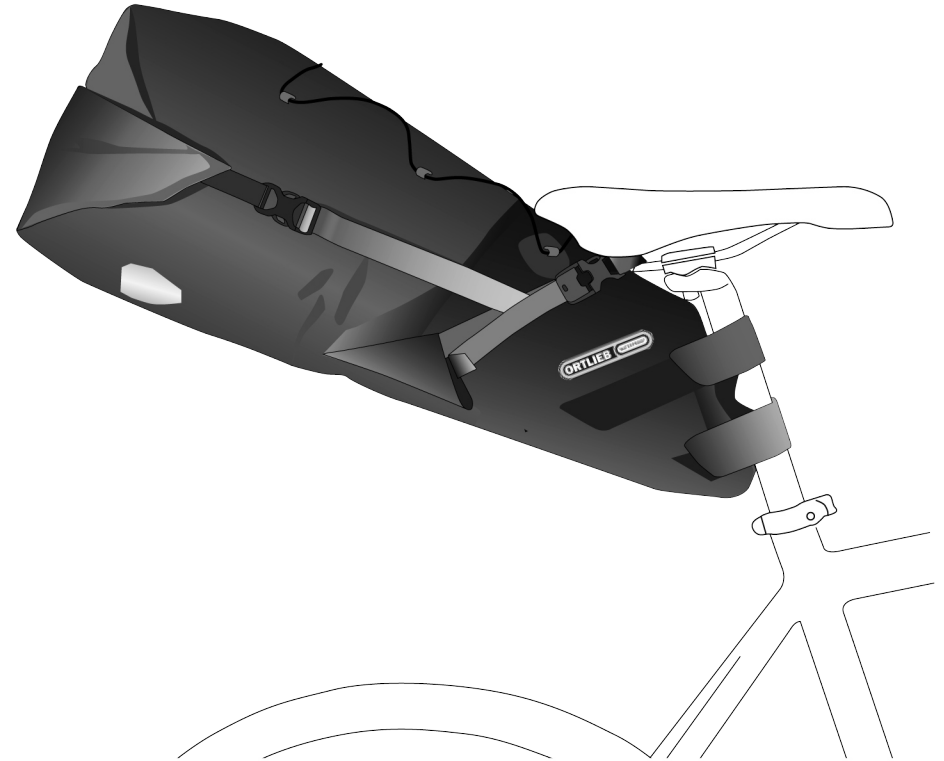
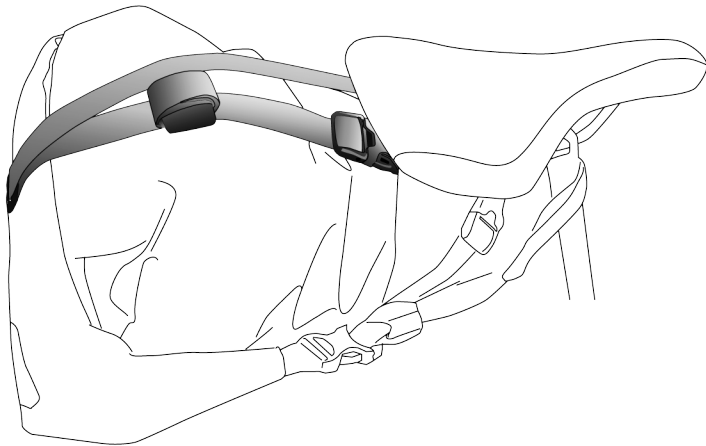
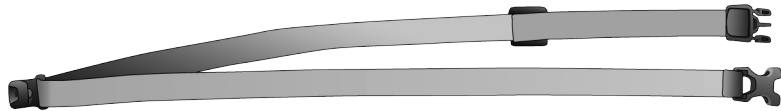

WEITERE INFORMATIONEN:

MORE INFORMATION:

<https://www.youtube.com/watch?v=CuMWYUYhSoM>

[www.ortlieb.com](http://www.ortlieb.com)



WA133 0820

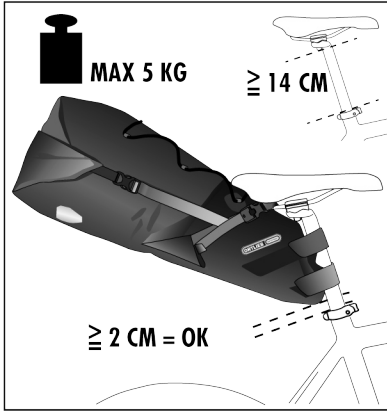

1.1

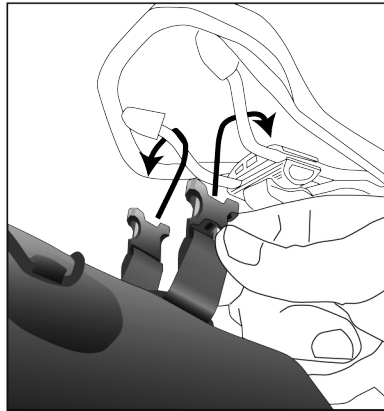

1.2

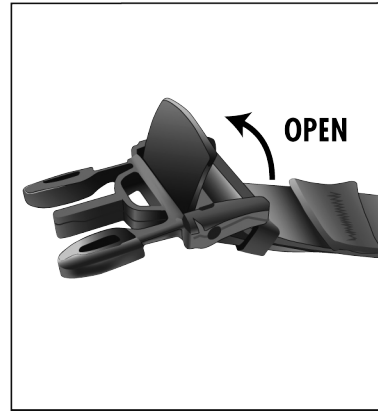

1.3

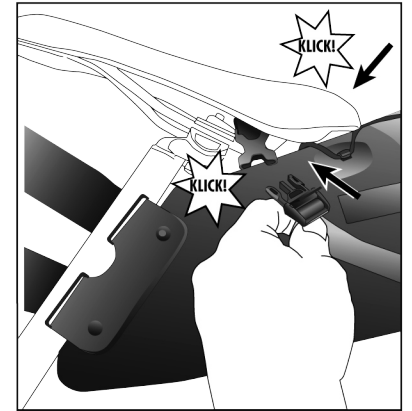

1.4

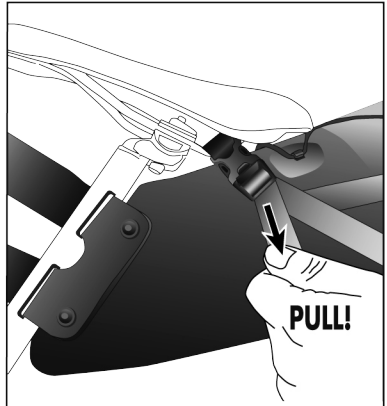

1.5

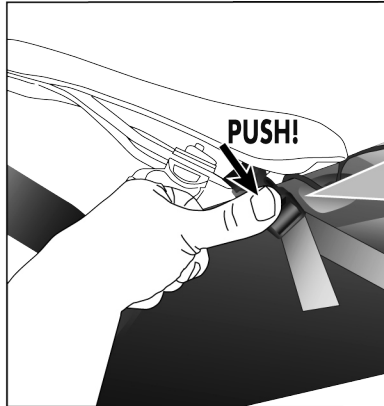

1.6

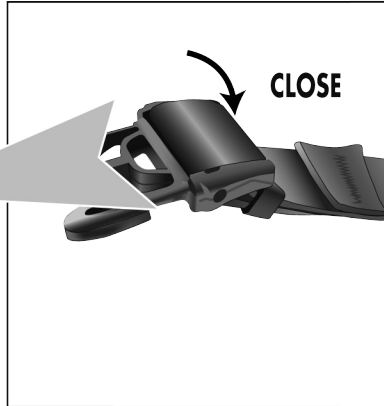

1.7

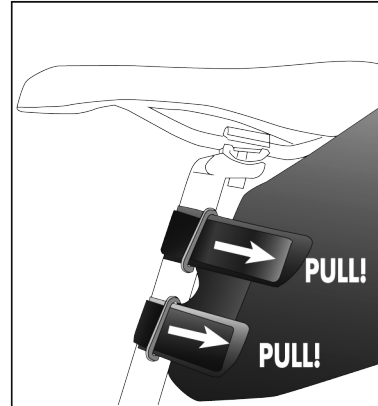

1.8

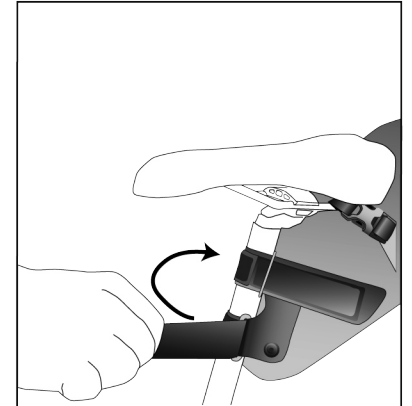

2.1

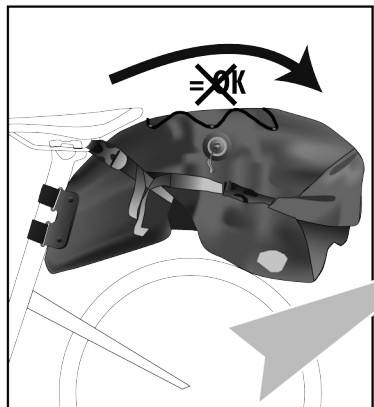

2.2

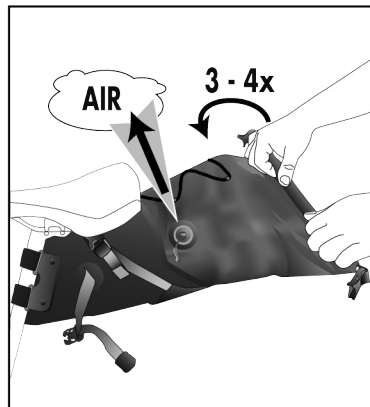
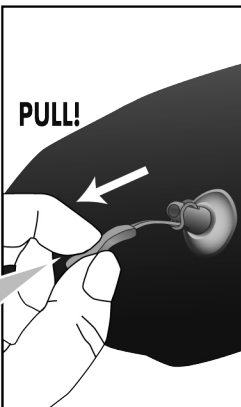

2.3

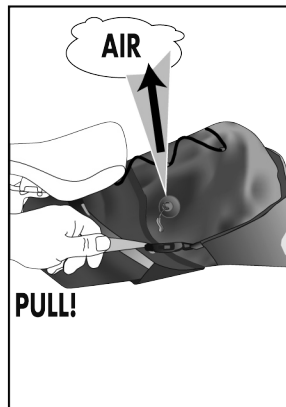

2.4

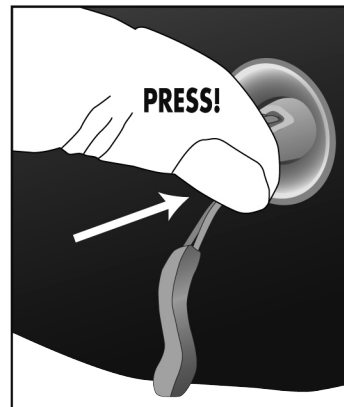

2.5

